

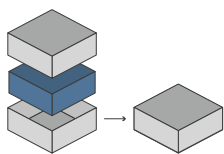

## ORGANIZER - COMPATIBLE WITH ARK NOVA - ALL IN (BASE GAME OR WITH MARINE WORLDS EXP)



Designed to fit into the game box; flush closure is guaranteed. Progettato per inserirsi all'interno della scatola del gioco; garantisce chiusura a filo\*



Designed for both sleeved and unsleeved cards. Adatto sia per carte imbustate che non imbustate\*

35.1 x 28.6 x 5.8 cm



Size of assembled organiser  
Dimensioni organizer assemblato

### ORGANIZER CAPACITY

4x player set boxes; 2x card holders, with dedicated slots; 1x enclosure tray, with slots for each value; 3x trays for special enclosures, universities and partner zoos; 3x unique building trays; 1x resource holder, with dedicated slots; 1x tray for pause meeple and bonus tiles. 4x scatole set giocatore; 2x portacarte, con slot dedicati; 1x vassoio per recinti, divisi per valore; 3x vassoi per recinti speciali, università e zoo partner; 3x vassoi per token edifici unici; 1x portarisorsa con slot dedicati; 1x contenitore per meeple pausa e tessere bonus.



\* Any doubt?  
Check out our FAQ page or download the digital version of the instructions on our website!

All trademarks and copyrights are the property of their respective owners.  
This product is not a toy. Contains small parts that can be swallowed or inhaled. 14+





## ORGANIZER - COMPATIBLE WITH ARK NOVA - ALL IN



### TUTORIAL - THE DICETROYERS DICE!

Among the pieces to assemble, you'll find a dice. This is not part of the organizer, but it can be a good starting point to practice!

Tra i materiali da assemblare troverai un dado. Questo componente non fa parte dell'organizer, né del gioco, ma è un ottimo punto di partenza per fare un po' di pratica.

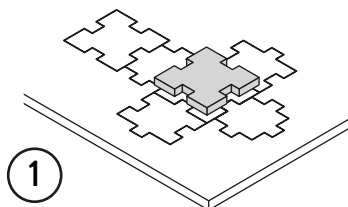

1

Gently take off  
all the pieces.  
Stacca delicatamente  
dal foglio tutti i pezzi.

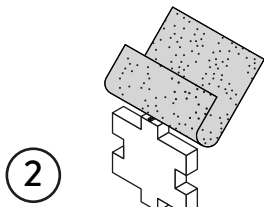

2

If necessary, use sand paper to  
smoothen the borders.  
Se necessario rifila con carta  
vetrata per legno eventuali  
imperfezioni dei pezzi.

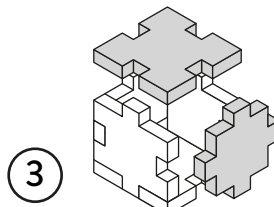

3

Get familiar with  
all the pieces  
and check the correct assembly  
sequence.  
Prendi familiarità con tutti  
i pezzi, per assicurarti  
che la sequenza di assemblaggio sia  
corretta.

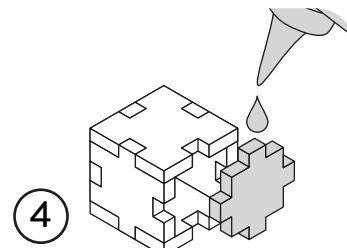

4

Once verified the correct assembly  
sequence, just add a small quantity  
of PVA glue on every joint.  
Dopo aver verificato  
la sequenza di assemblaggio  
aggiungi una piccola quantità di  
colla vinilica su tutti  
gli incastri per garantirne  
la durata nel tempo.

## INSTRUCTIONS

A



DT-162A

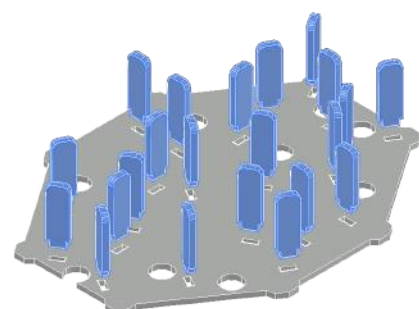
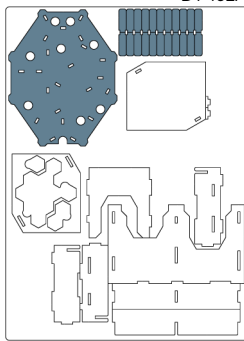

B

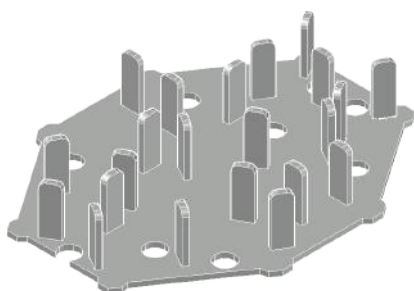

DT-162A

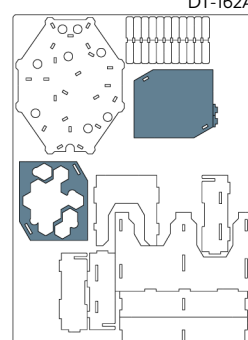

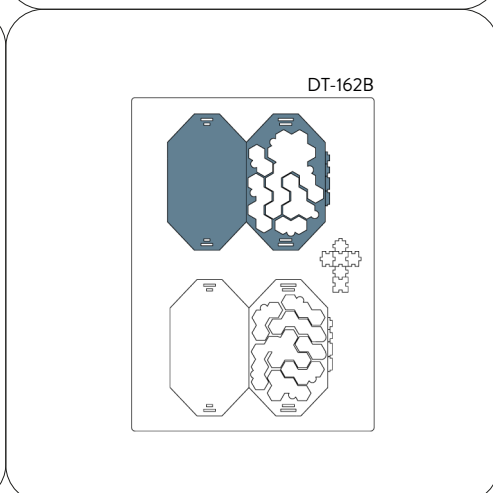
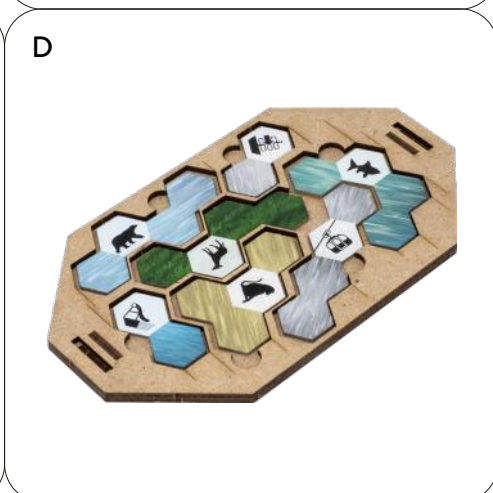
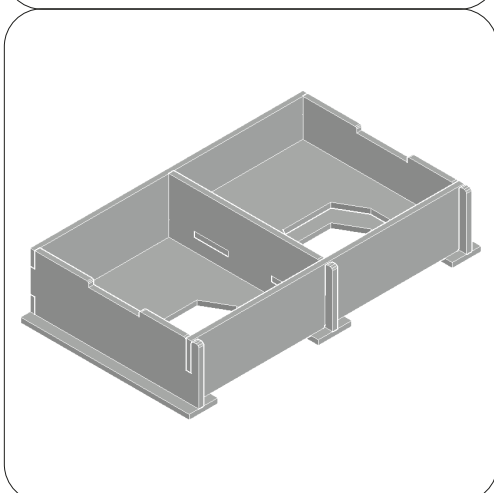
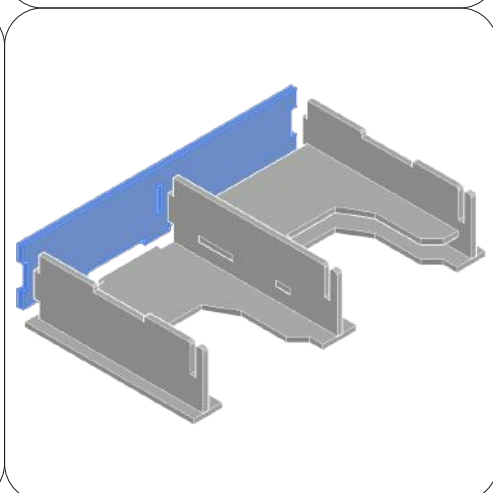
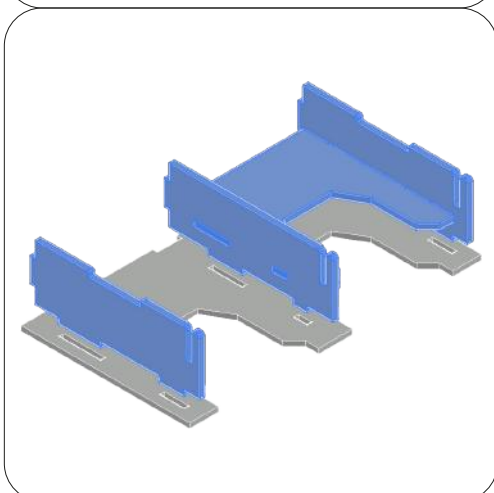
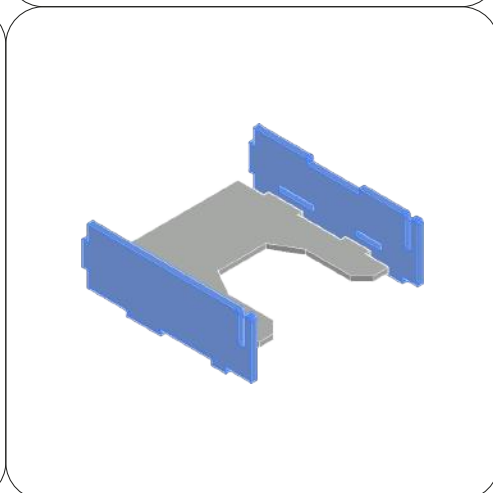
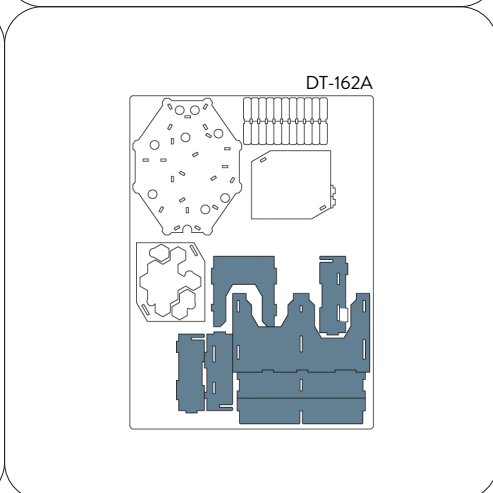
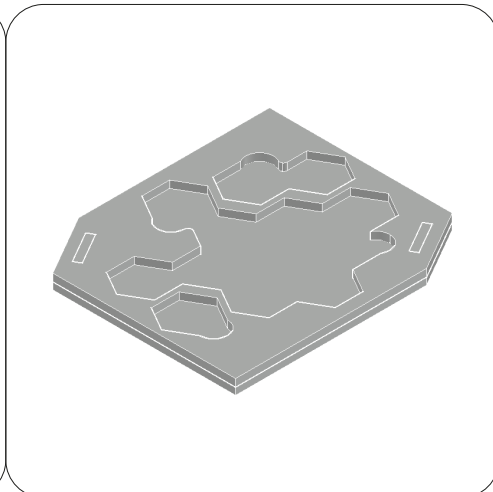
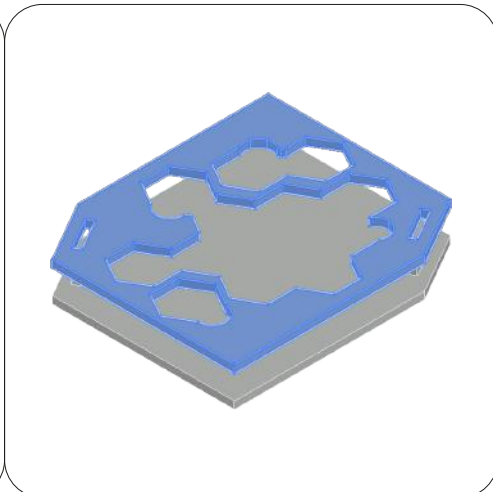
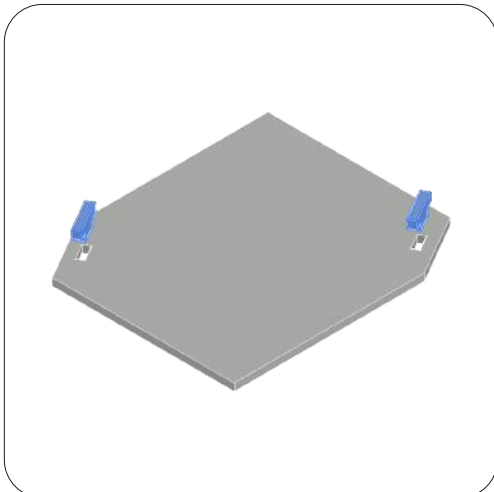

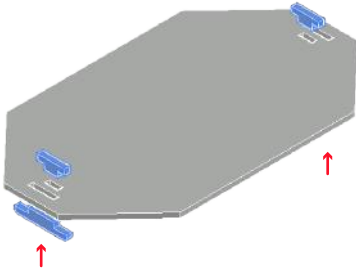

NOTE: The pins to be placed on the lower part are two. I piedini da posizionare nella parte inferiore sono due.

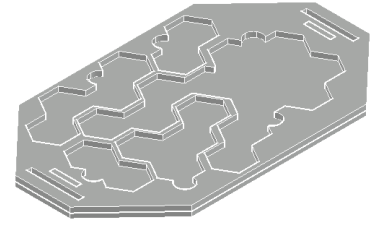
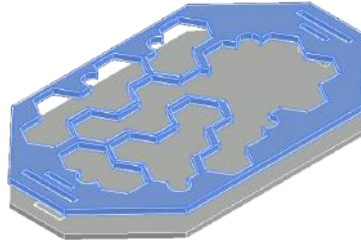

E

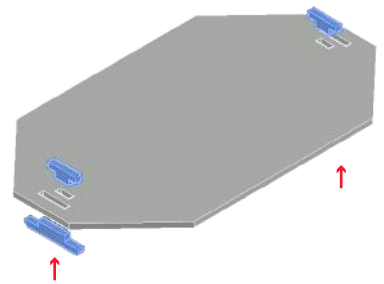
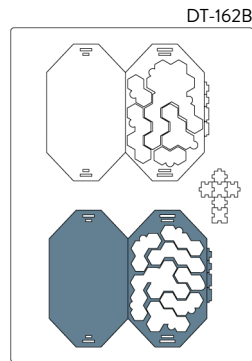

NOTE: The pins to be placed on the lower part are two. I piedini da posizionare nella parte inferiore sono due.

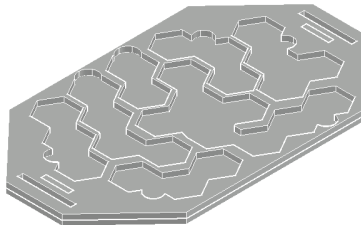
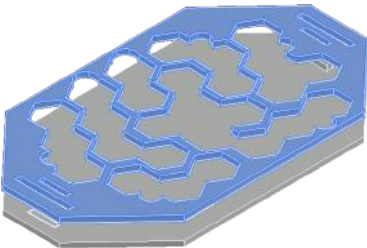

F

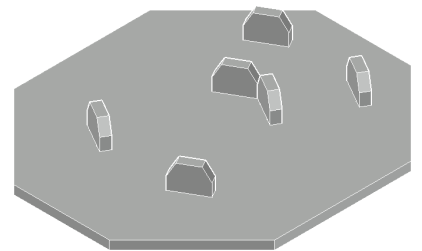
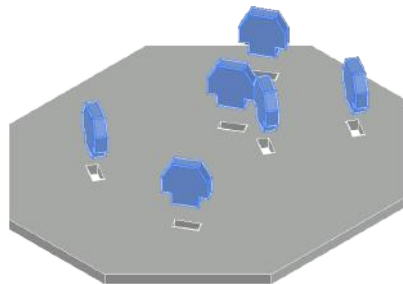
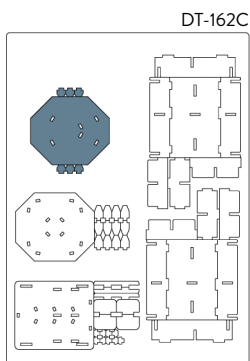
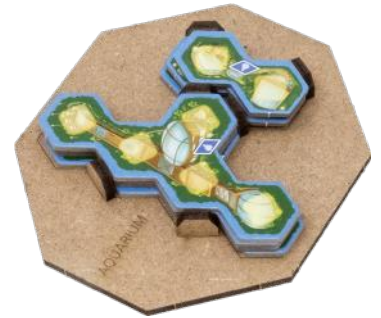

G



DT-162C

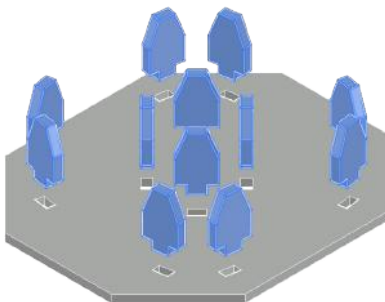
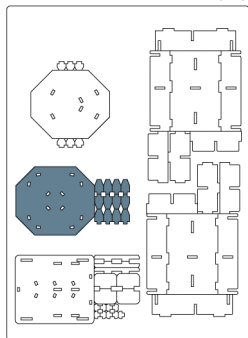

H

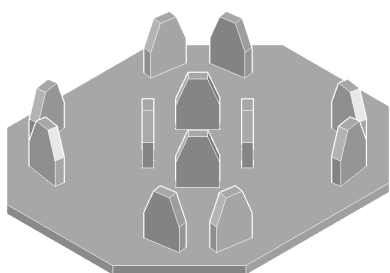

DT-162C

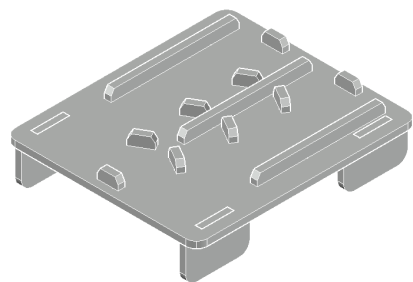
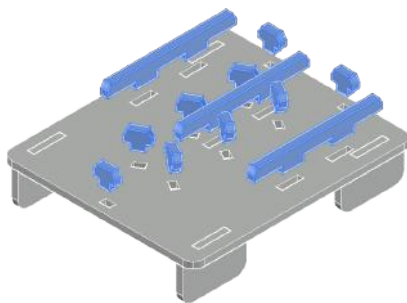
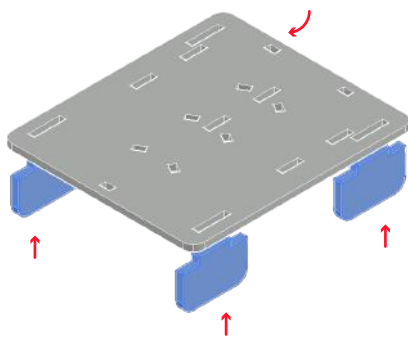
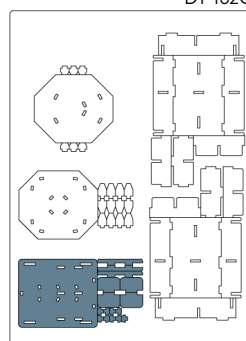

NOTE: The pins to be placed on the lower part are four. I piedini da posizionare nella parte inferiore sono quattro.

I

4x



DT-162C

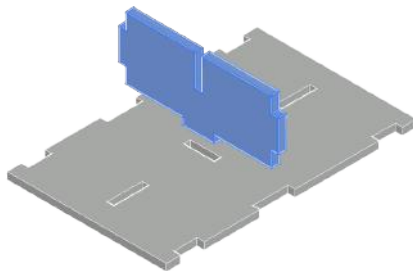
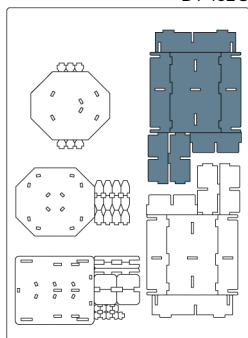

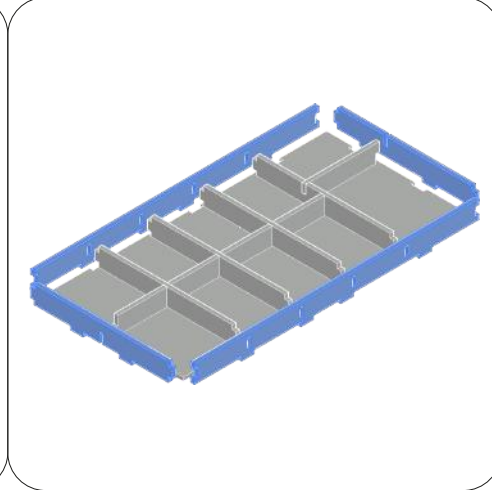
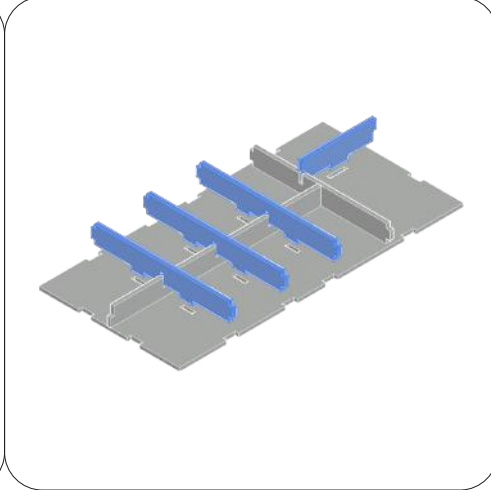
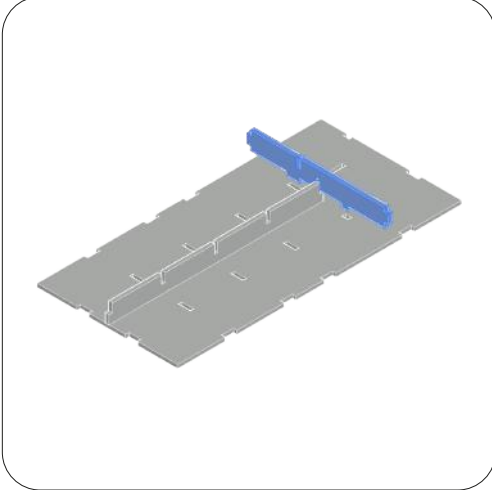
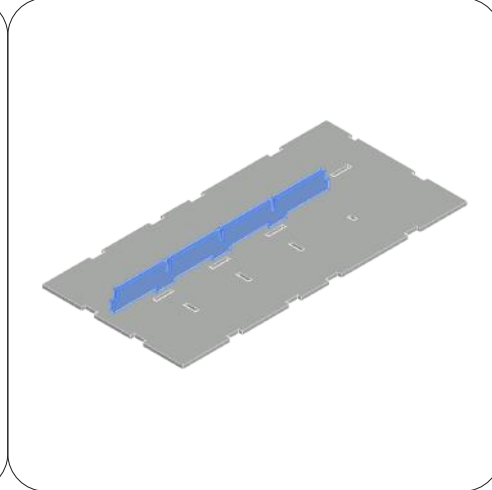
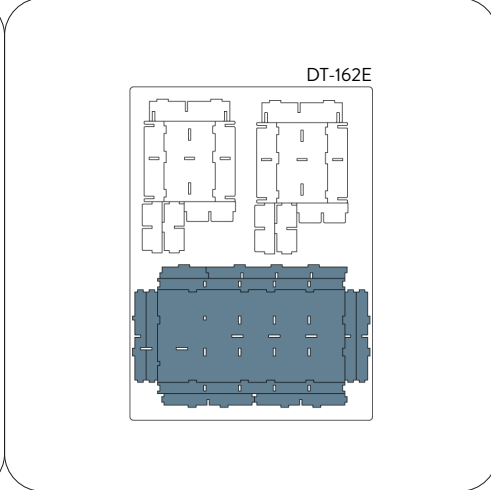
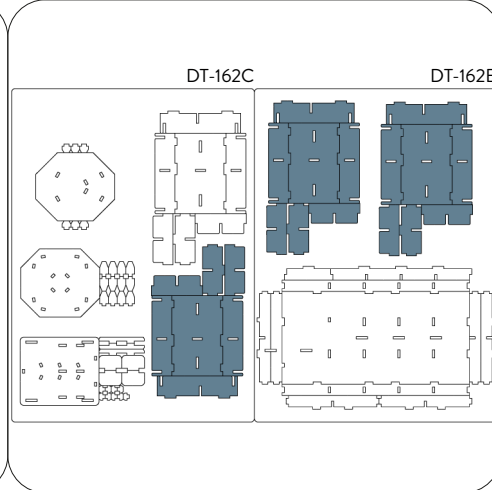
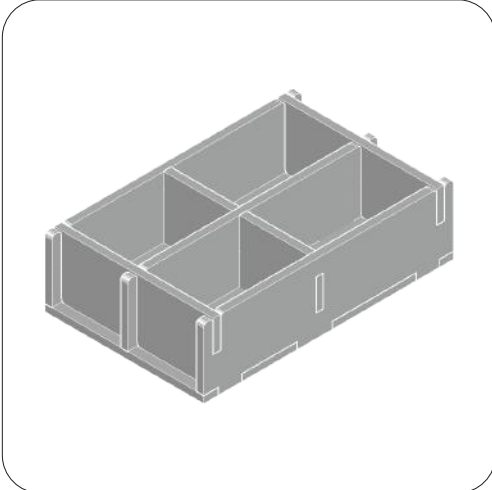
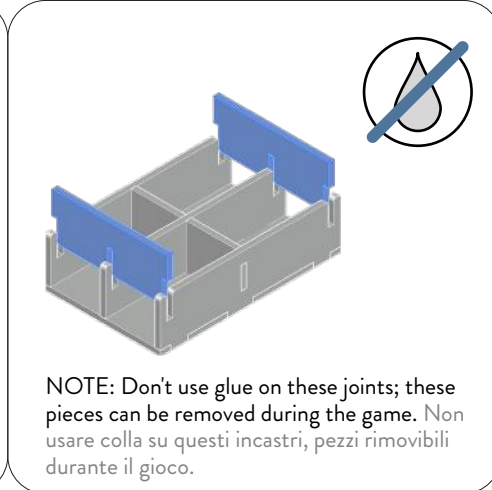
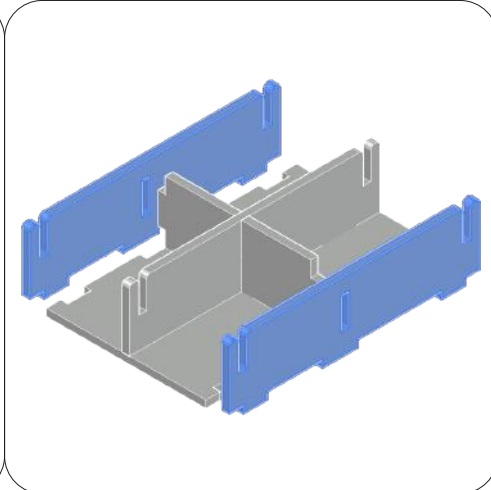
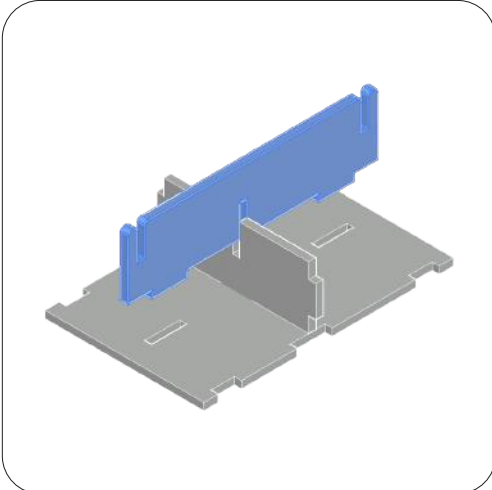

K

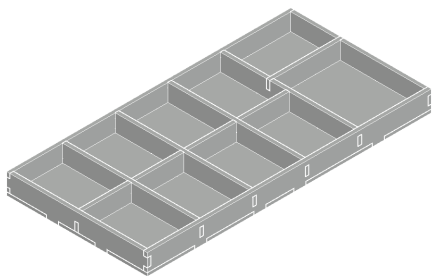

DT-162D

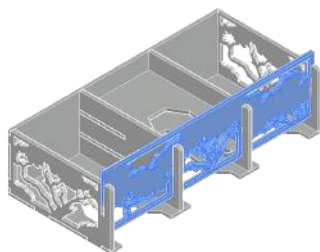
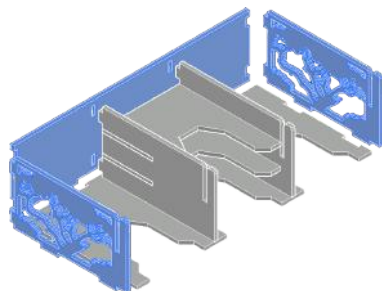
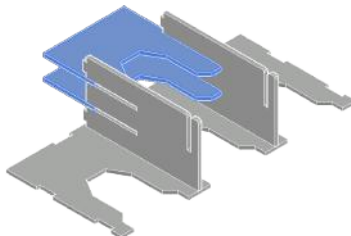
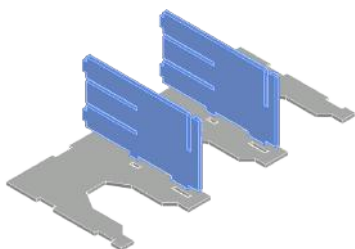
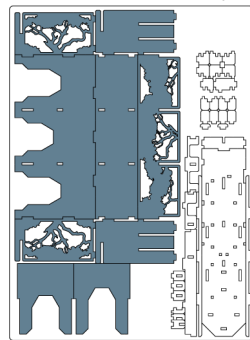

NOTE: Don't use glue on this joint; this piece can be removed during the game. Non usare colla su questo incastro, pezzo rimovibile durante il gioco.

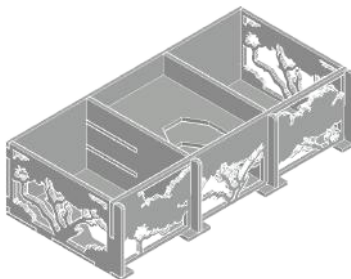

L



DT-162D

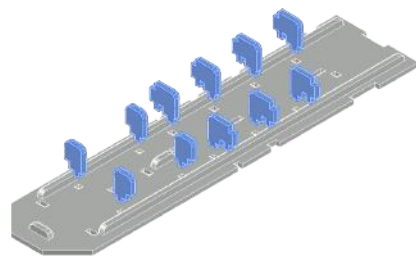
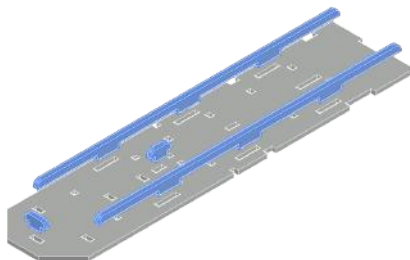
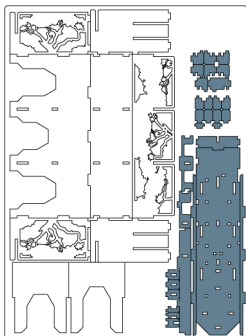

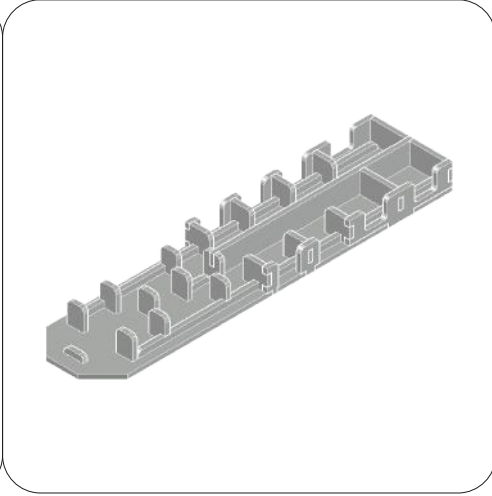
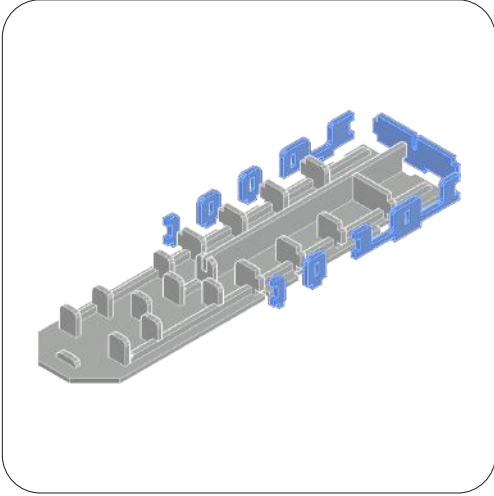
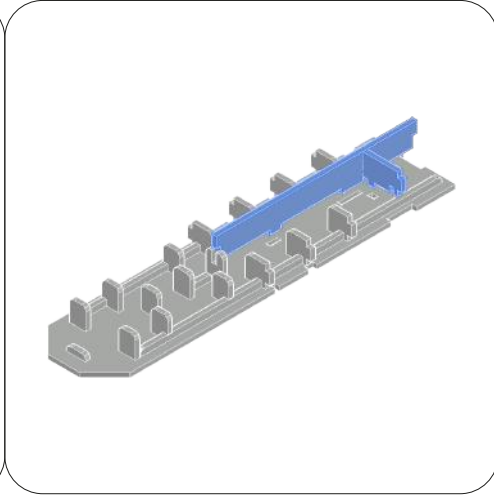
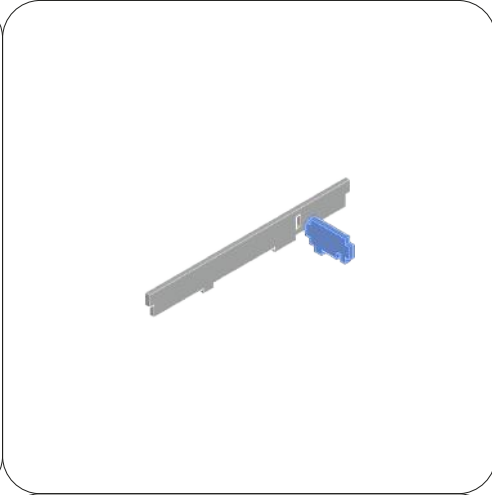
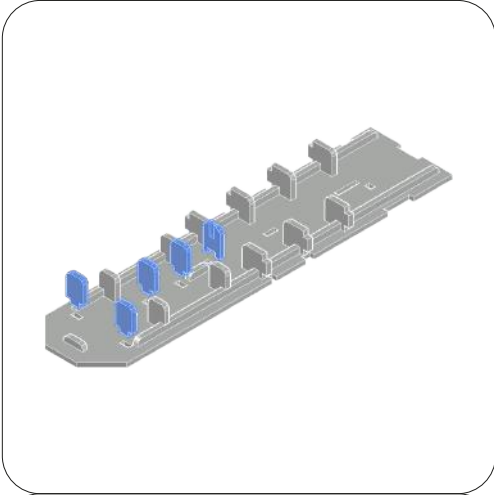

## REBOXING SEQUENCE!



Every piece will stay in its slot. Follow the reboxing sequence to properly store your organizer. We recommend using a h-band to avoid accidental box opening. Don't shake. Ogni componente rimarrà al suo posto. Segui la sequenza di reinserimento per riporre nella maniera corretta il tuo organizer. Consigliamo l'utilizzo di una h-band per evitare aperture accidentali. Non scuotere.



Non-recyclable waste. Smaltire i materiali di scarto nell'indifferenziata.

All trademarks and copyrights are the property of their respective owners.  
This product is not a toy. Contains small parts that can be swallowed or inhaled. 14+