

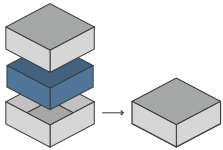

ORGANIZER - COMPATIBLE WITH RATS OF WISTAR



Designed to fit into the game box; flush closure is guaranteed. Progettato per inserirsi all'interno della scatola del gioco; garantisce chiusura a filo*



Designed for both sleeved and unsleeved cards. Adatto sia per carte imbustate che non imbustate*

30.2 x 21.2 x 5.25 cm

Size of assembled organiser
Dimensioni organizer assemblato

ORGANIZER CAPACITY

4x player set boxes, with dedicated slots; 1x card holder, with dedicated slots; 1x setup tray with slots for each component; 2x resource holders for pins and tokens; 1x tray for skill tiles. 4x scatole set giocatore, con slot dedicati; 1x portacarte con slot dedicati; 1x vassoio setup con slot per ogni componente; 2x portarisorse per segnalini e token; 1x vassoio per tile abilità.

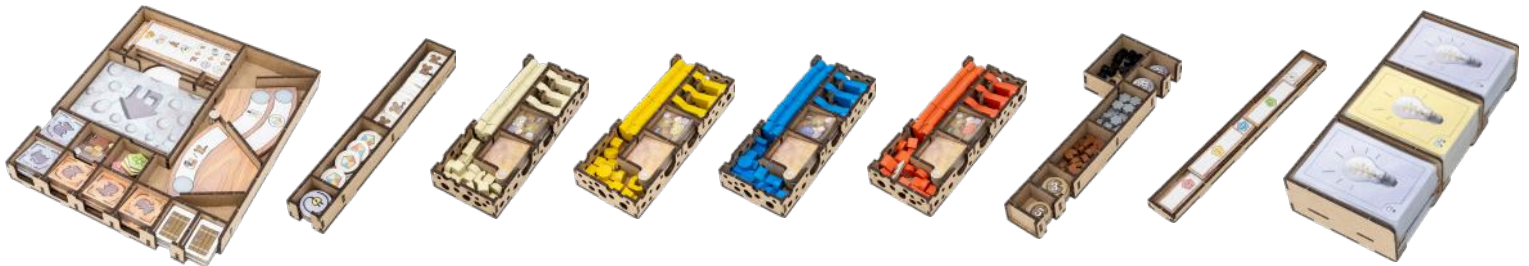

* Any doubt? Check out our FAQ page or download the digital version of the instructions on our website!

All trademarks and copyrights are the property of their respective owners. This product is not a toy. Contains small parts that can be swallowed or inhaled. 14+





ORGANIZER - COMPATIBLE WITH RATS OF WISTAR

TUTORIAL - THE DICETROYERS DICE!

Among the pieces to assemble, you'll find a dice. This is not part of the organizer, but it can be a good starting point to practice!

Tra i materiali da assemblare troverai un dado. Questo componente non fa parte dell'organizer, né del gioco, ma è un ottimo punto di partenza per fare un po' di pratica.

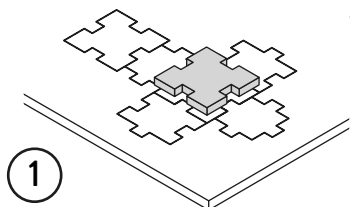

1

Gently take off
all the pieces.
Stacca delicatamente
dal foglio tutti i pezzi.

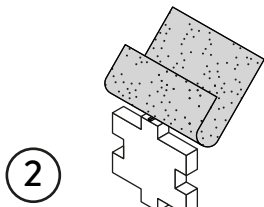

2

If necessary, use sand paper to
smoothen the borders.
Se necessario rifila con carta
vetrata per legno eventuali
imperfezioni dei pezzi.

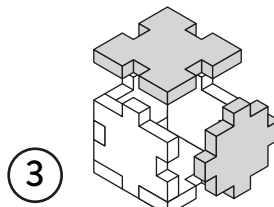

3

Get familiar with
all the pieces
and check the correct assembly
sequence.
Prendi familiarità con tutti
i pezzi, per assicurarti
che la sequenza di assemblaggio sia
corretta.

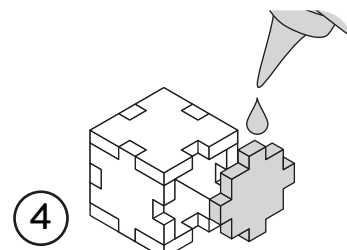

4

Once verified the correct assembly
sequence, just add a small quantity
of PVA glue on every joint.
Dopo aver verificato
la sequenza di assemblaggio
aggiungi una piccola quantità di
colla vinilica su tutti
gli incastri per garantirne
la durata nel tempo.

INSTRUCTIONS

A



161A

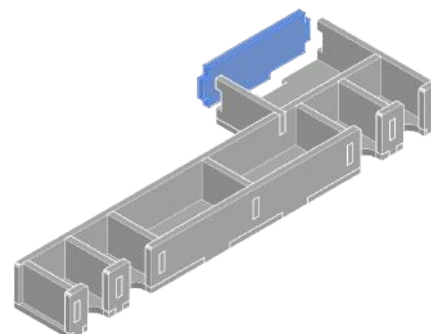
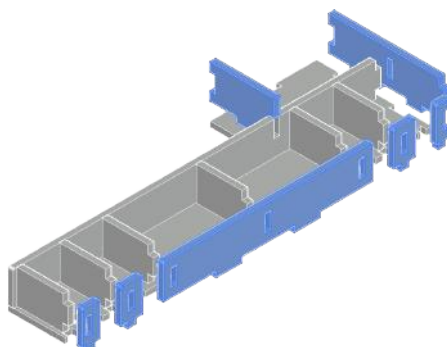
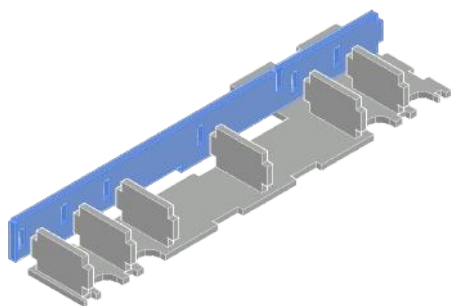
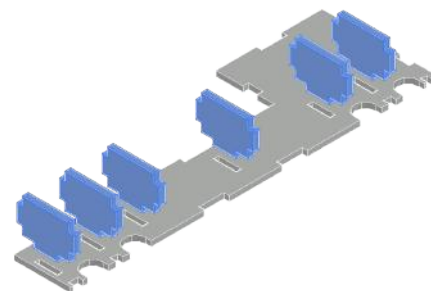
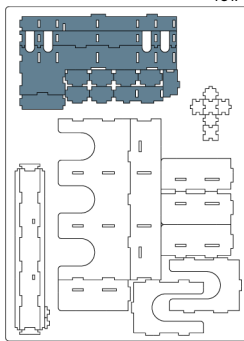

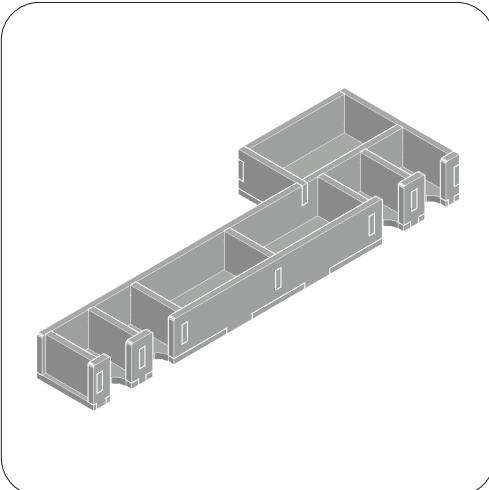

B

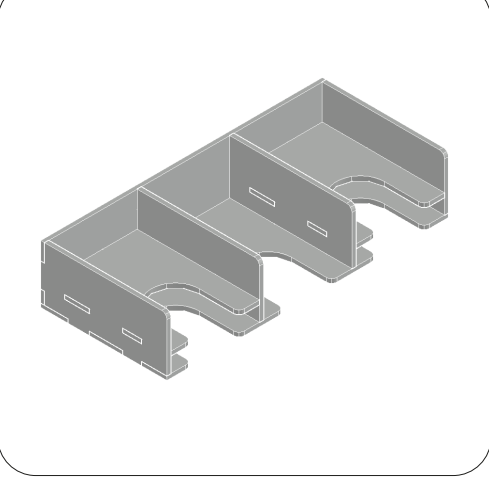
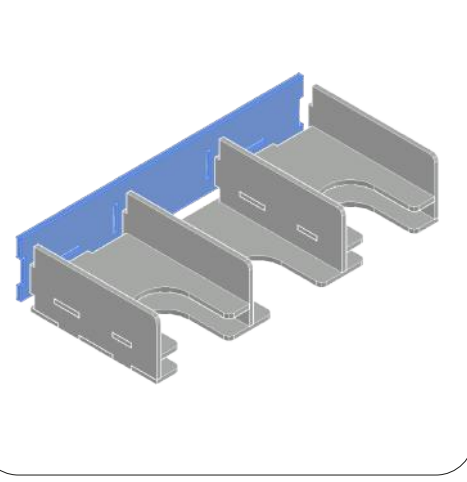
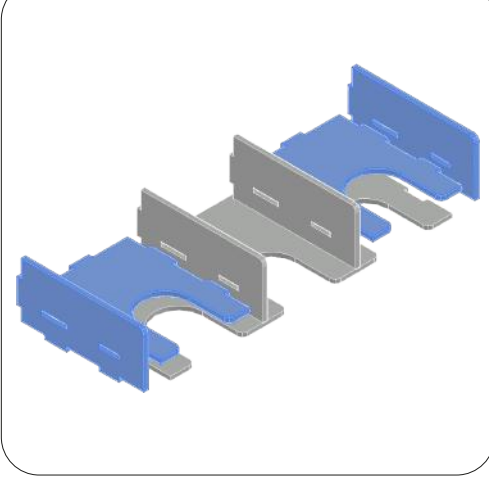
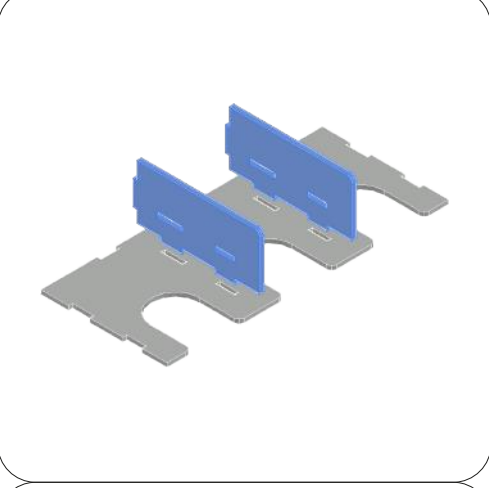
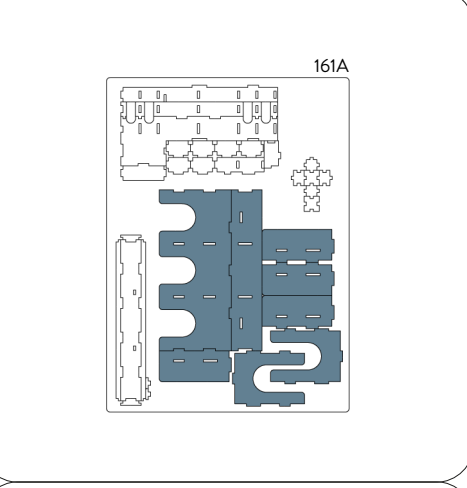
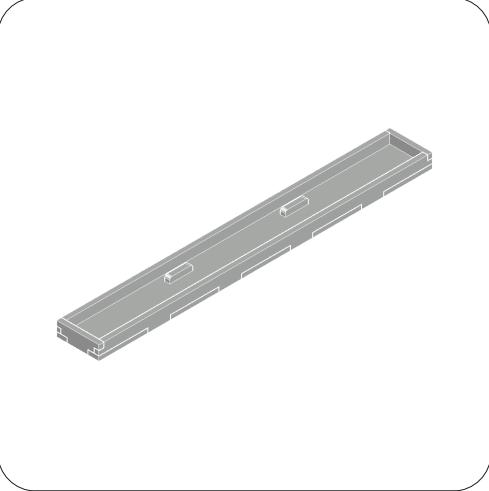
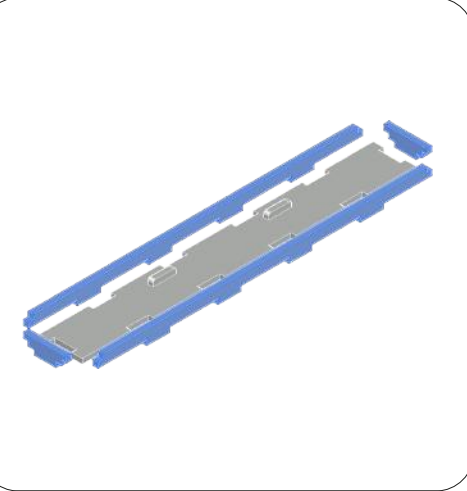
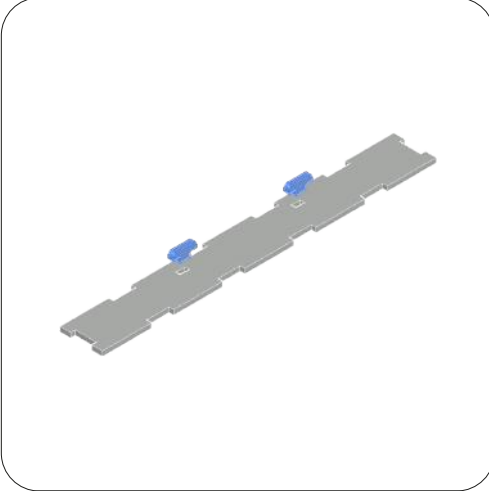
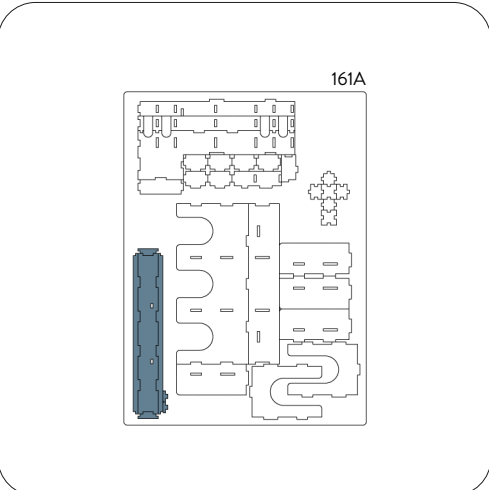

D



161B

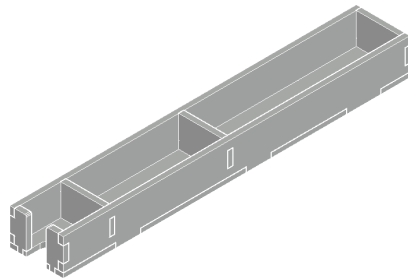
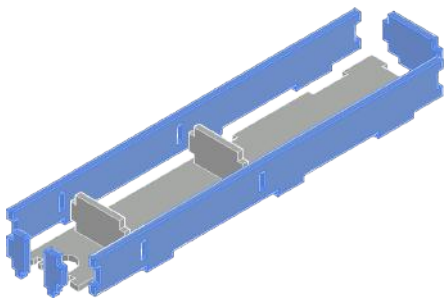
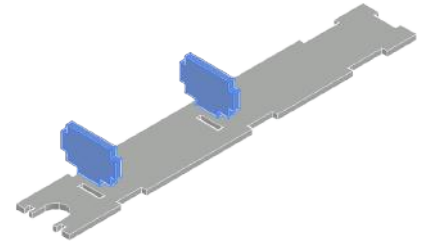
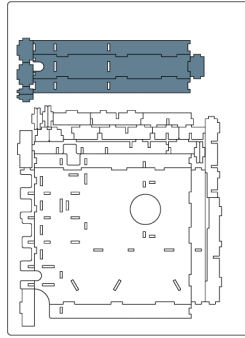

E



161B

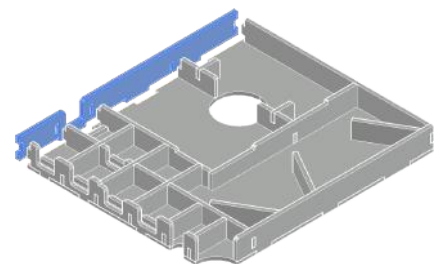
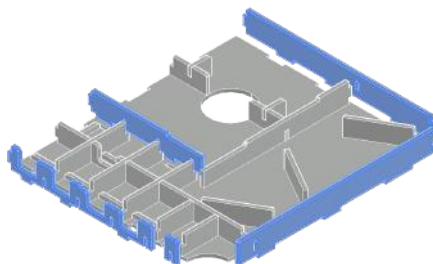
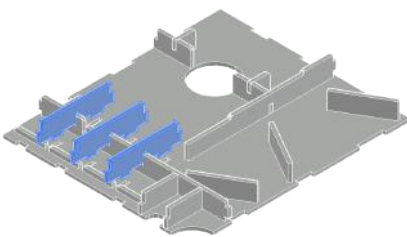
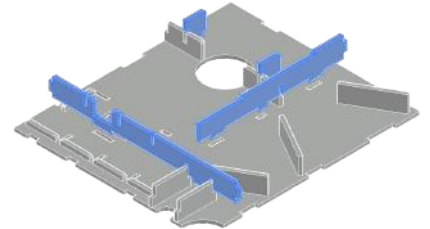
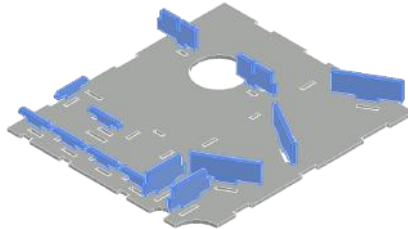
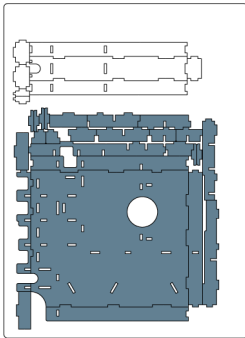

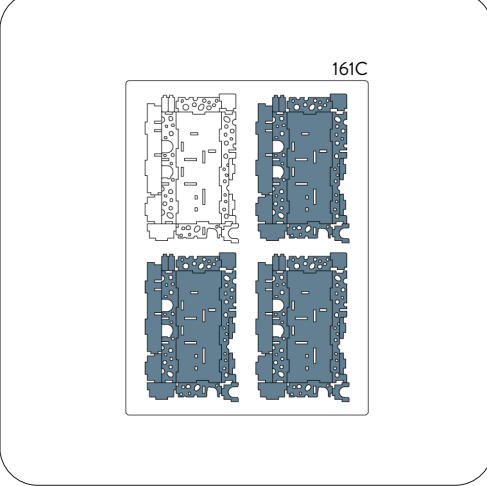
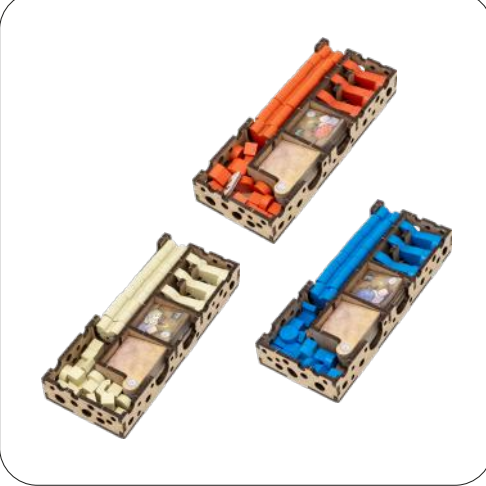
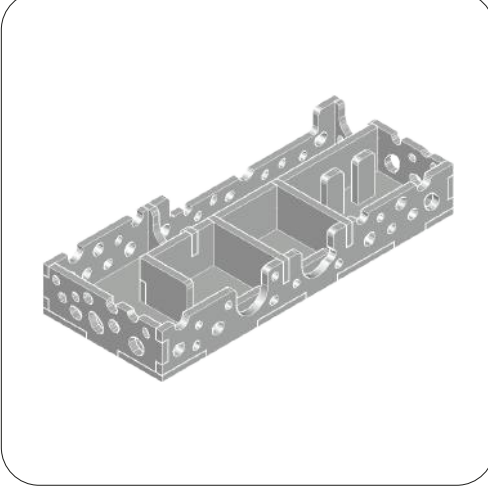
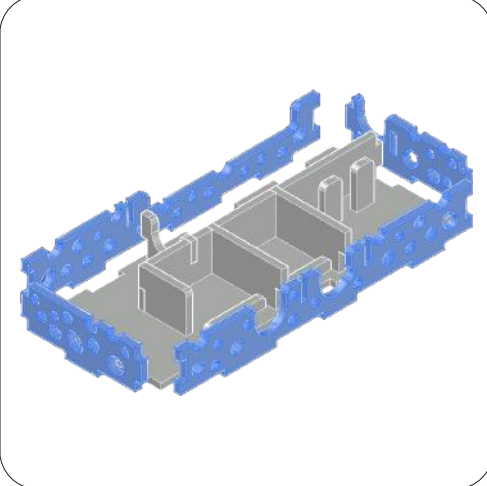
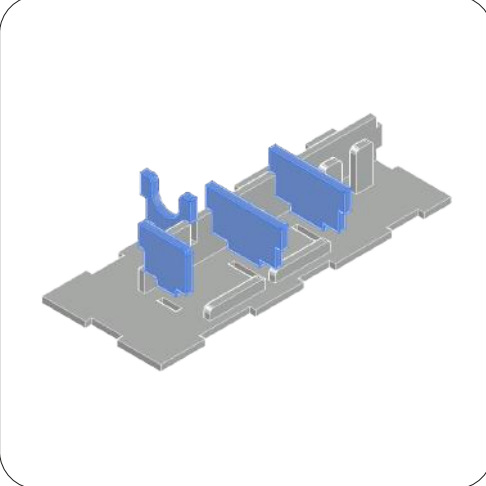
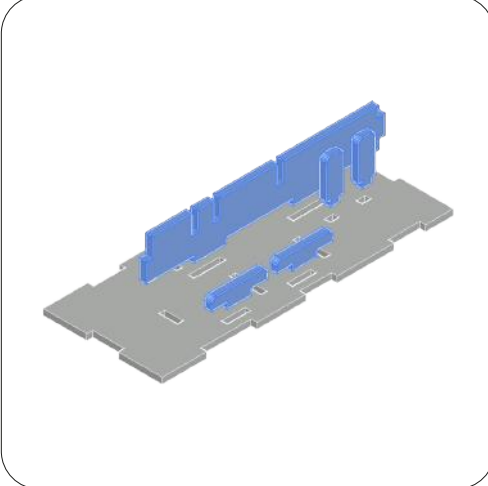
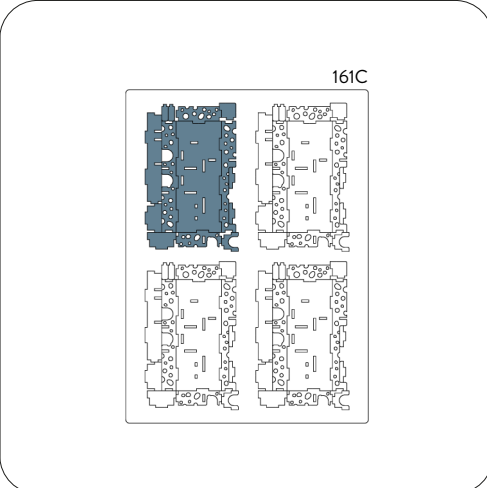
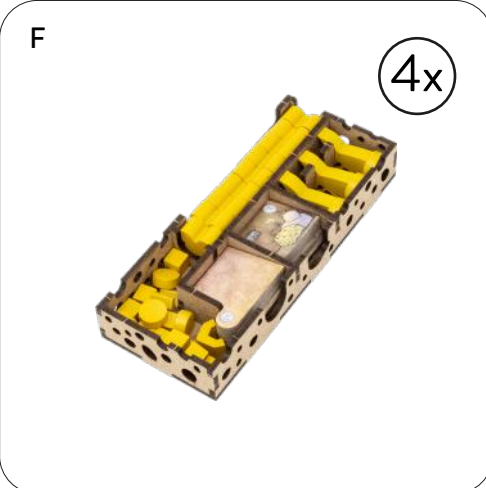
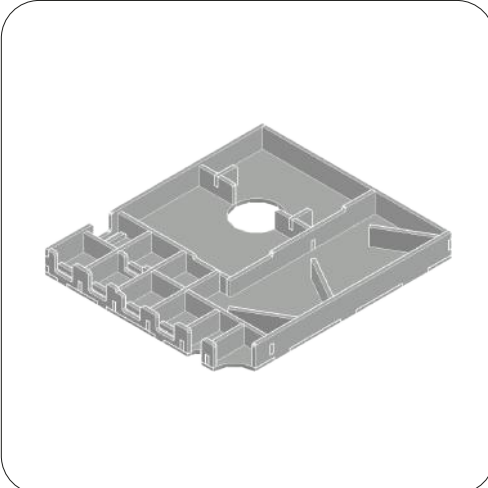

REBOXING SEQUENCE!



1



2

Place the tray for skill tiles here.
Posiziona la tray per le tile abilità.



3

Place the wheel upside down as you see in the picture, move it with your hand until you feel it lock. Posiziona la ruota capovolta come vedi nell'immagine, muovila con la mano fintanto che non la senti bloccarsi.



4



5



6



Every piece will stay in its slot. Follow the reboxing sequence to properly store your organizer. We recommend using a h-band to avoid accidental box opening. Don't shake. Ogni componente rimarrà al suo posto. Segui la sequenza di reinserimento per riporre nella maniera corretta il tuo organizer. Consigliamo l'utilizzo di una h-band per evitare aperture accidentali. Non scuotere.

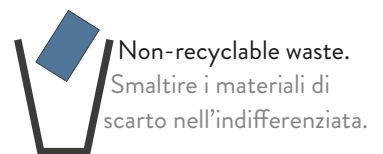

Non-recyclable waste.
Smaltire i materiali di scarto nell'indifferenziata.

All trademarks and copyrights are the property of their respective owners.
This product is not a toy. Contains small parts that can be swallowed or inhaled. 14+