

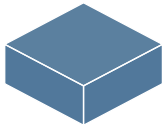

ORGANIZER - COMPATIBLE WITH AGE OF INNOVATION

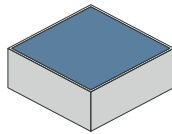

35.1 x 28.6 x 7.8 cm
SIZE ONCE ASSEMBLED



FITS INTO THE GAME BOX.
FLUSH CLOSURE



FITS BOTH SLEEVED
AND UNSLEEVED CARDS

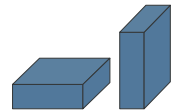

COMPATIBLE WITH
BOTH HORIZONTAL OR
VERTICAL STORAGE



Any doubt?
Check out our FAQ page
or download the digital
version of the instructions
on our website!

All trademarks and copyrights are the property of their respective owners.
This product is not a toy. Contains small parts that can be swallowed or inhaled. 14+



ORGANIZER - COMPATIBLE WITH AGE OF INNOVATION



TUTORIAL - THE DICETROYERS DICE!

Among the pieces to assemble, you'll find a dice. This is not part of the organizer, but it can be a good starting point to practice!

Tra i materiali da assemblare troverai un dado. Questo componente non fa parte dell'organizer, né del gioco, ma è un ottimo punto di partenza per fare un po' di pratica.

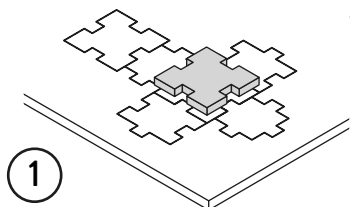

1

Gently take off
all the pieces.
Stacca delicatamente
dal foglio tutti i pezzi.

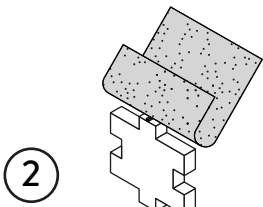

2

If necessary, use sand paper to
smoothen the borders.
Se necessario rifila con carta
vetrata per legno eventuali
imperfezioni dei pezzi.

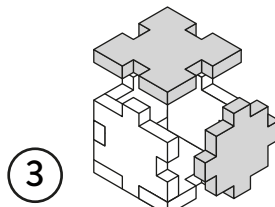

3

Get familiar with
all the pieces
and check the correct assembly
sequence.
Prendi familiarità con tutti
i pezzi, per assicurarti
che la sequenza di assemblaggio sia
corretta.

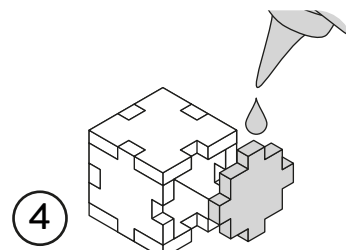

4

Once verified the correct assembly
sequence, just add a small quantity
of PVA glue on every joint.
Dopo aver verificato
la sequenza di assemblaggio
aggiungi una piccola quantità di
colla vinilica su tutti
gli incastri per garantirne
la durata nel tempo.

INSTRUCTIONS

A



169 A

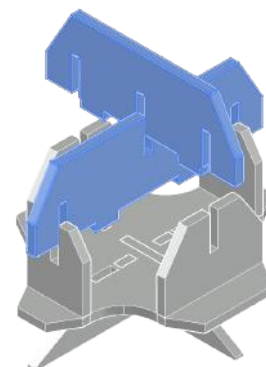
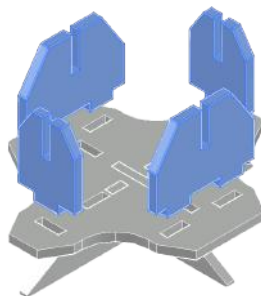
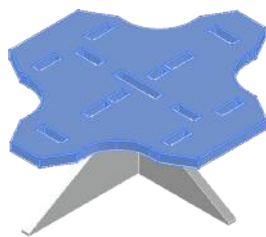
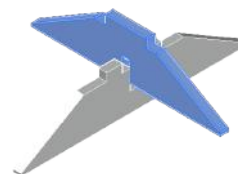
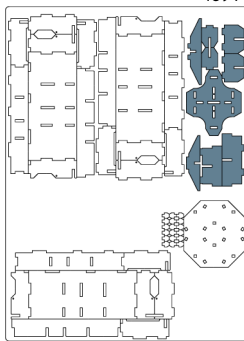

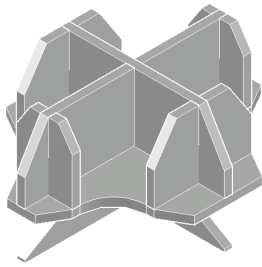

B



169 A

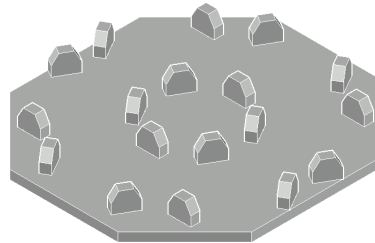
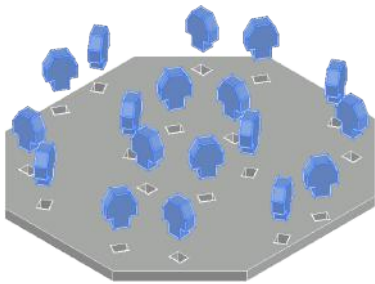
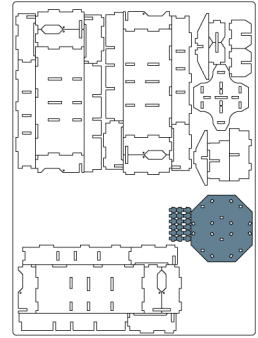

C



7x



169 A

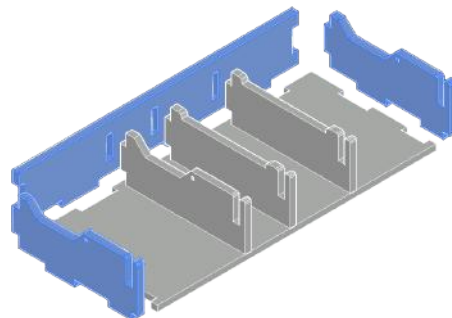
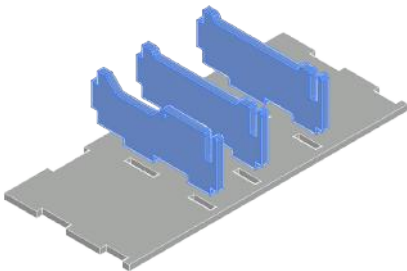
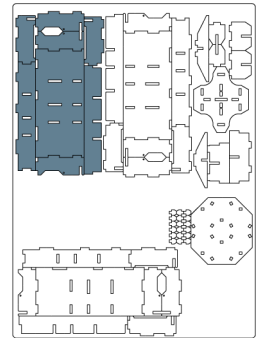

NOTE: Don't use glue on this joint; this piece can be removed during the game. Non usare colla su questo incastro, pezzo rimovibile durante il gioco.

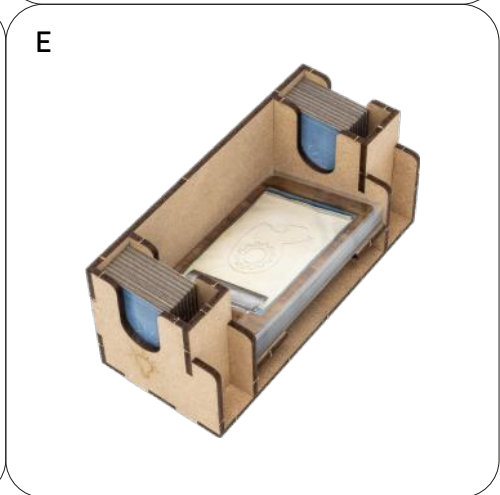
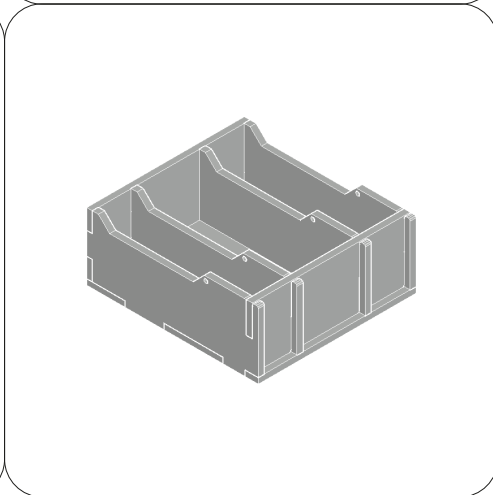
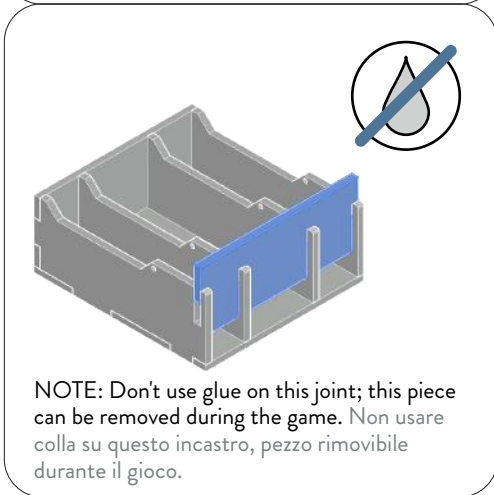
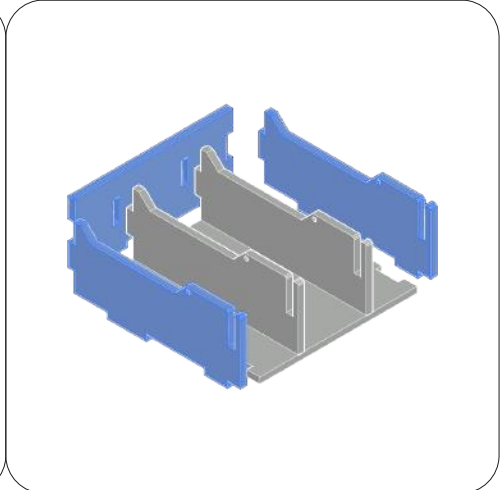
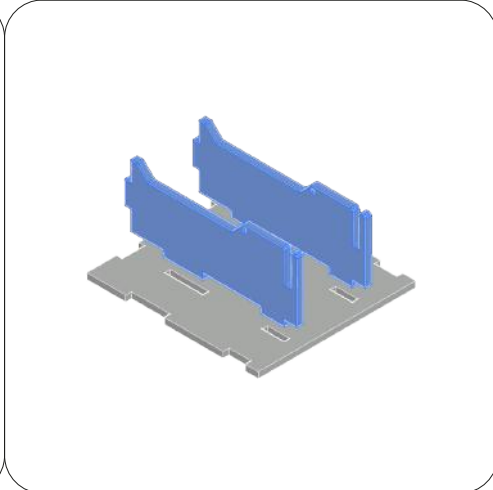
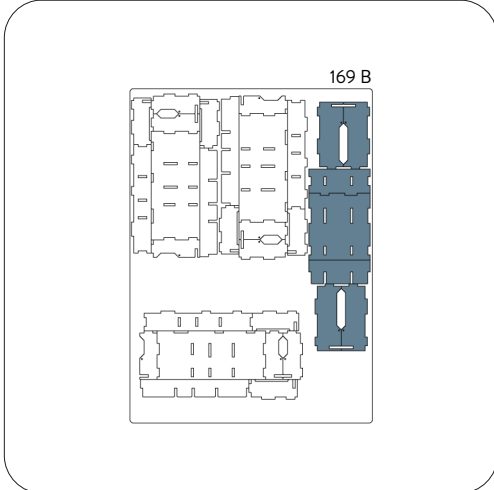
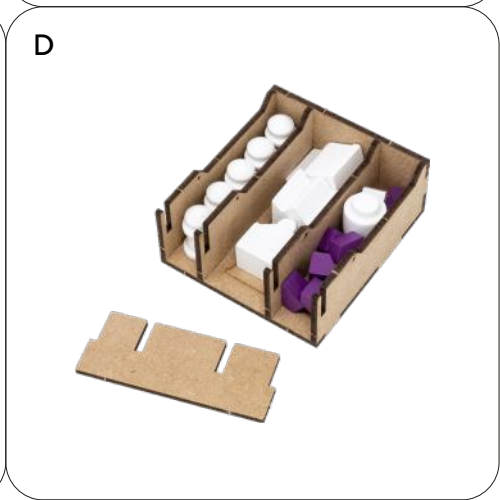
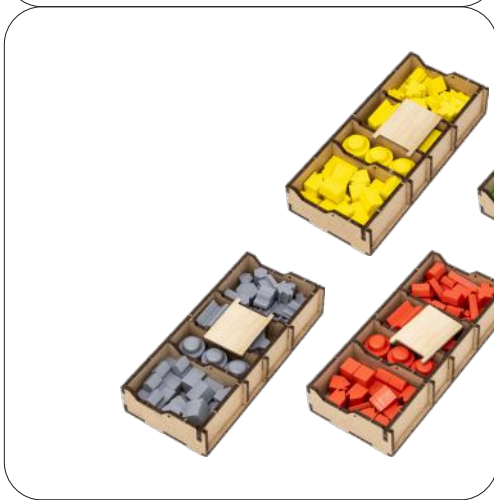
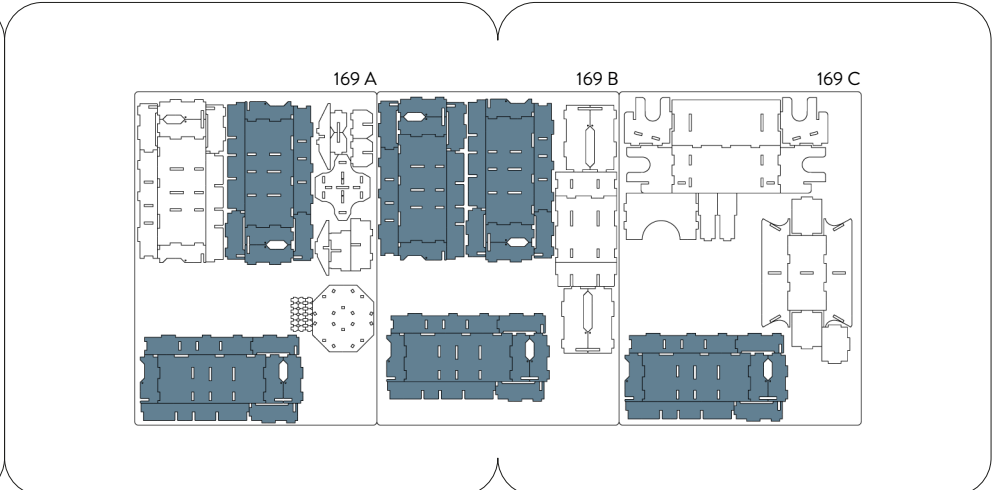
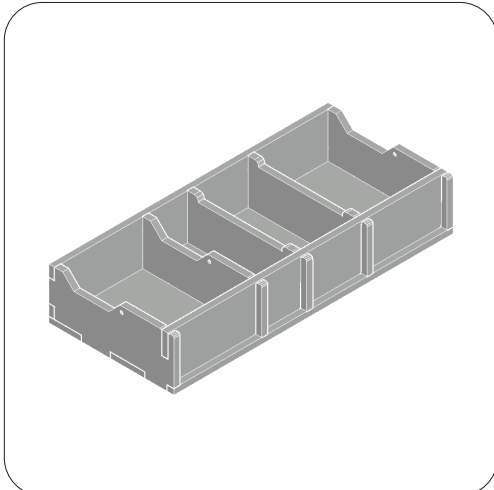

169 C

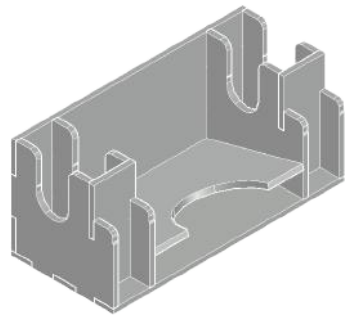
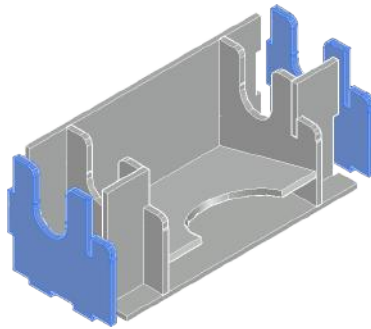
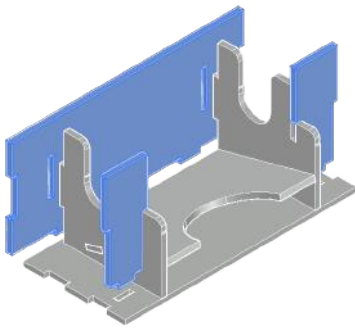
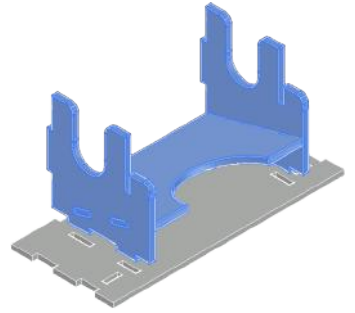
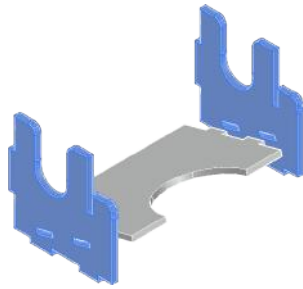
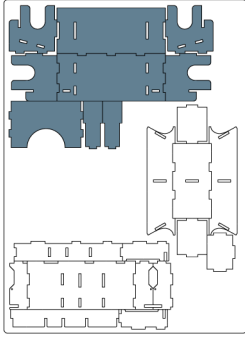

F



169 C

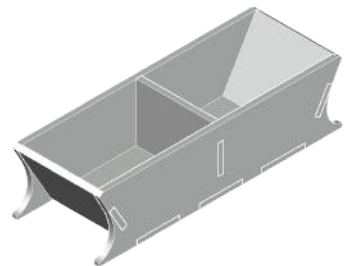
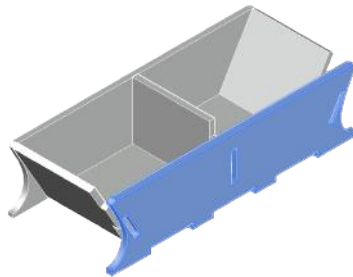
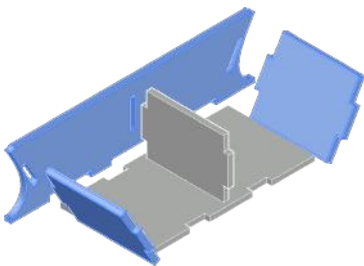
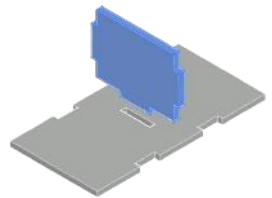
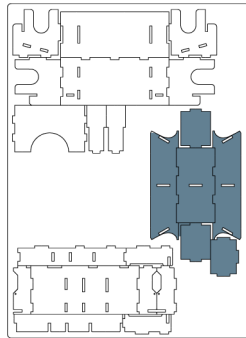

G



169 D

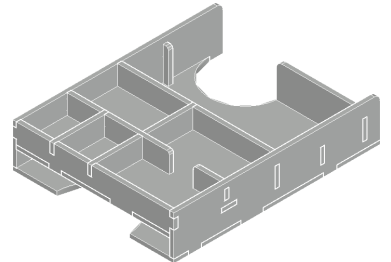
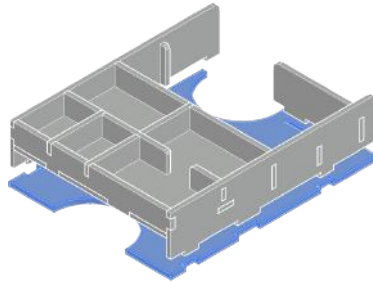
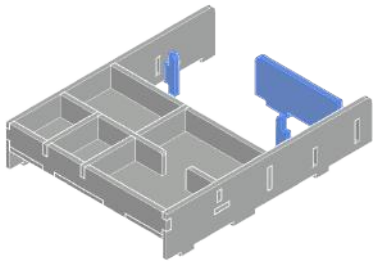
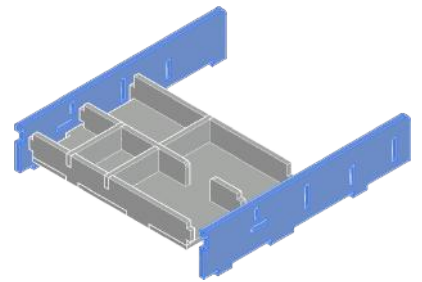
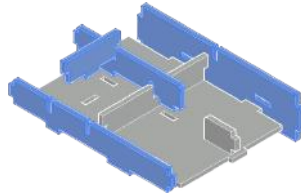
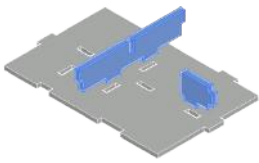
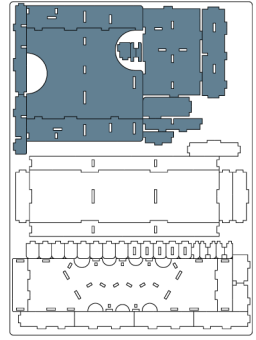

H



169 D

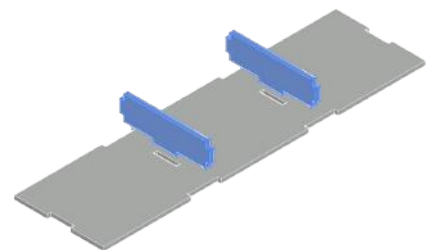
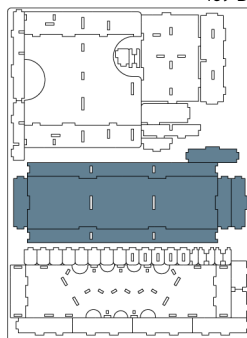

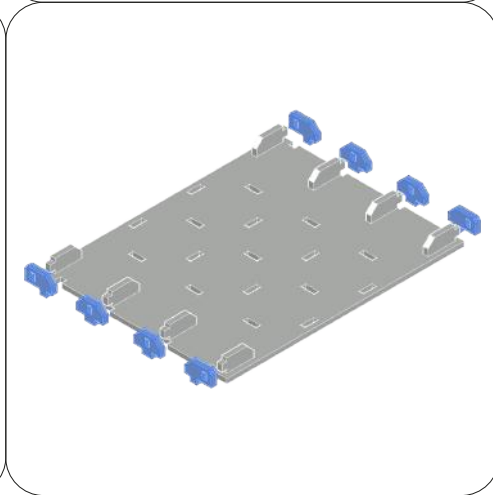
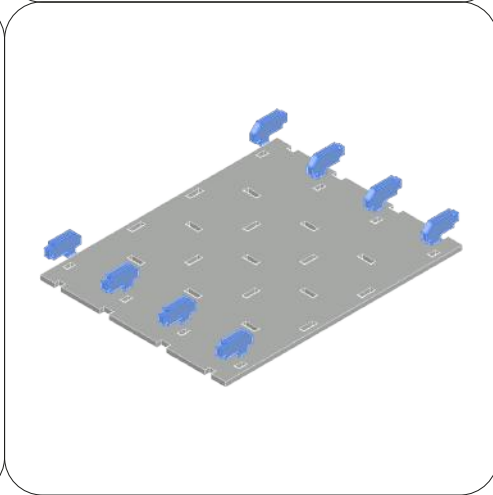
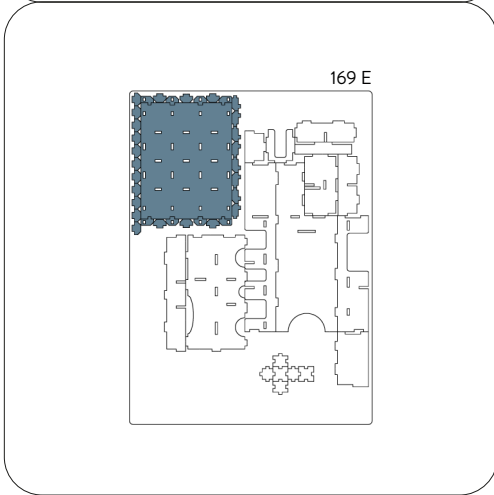
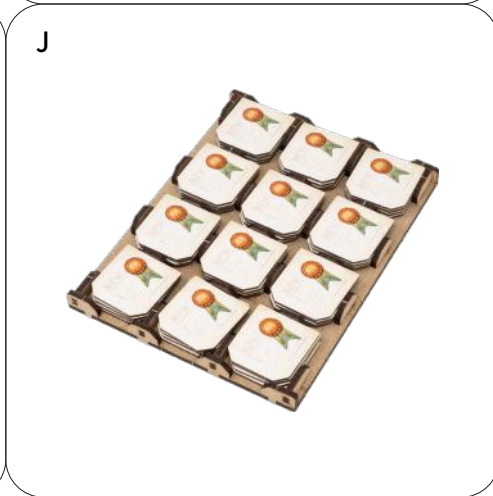
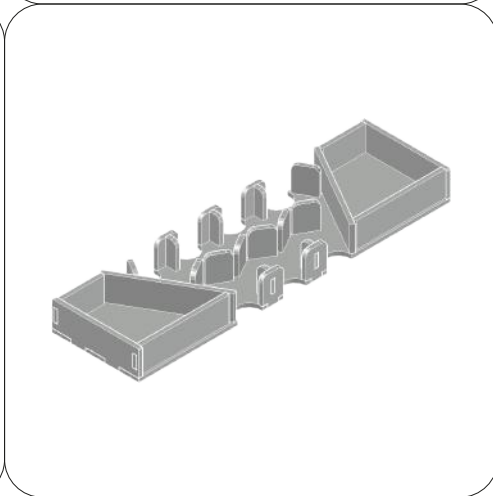
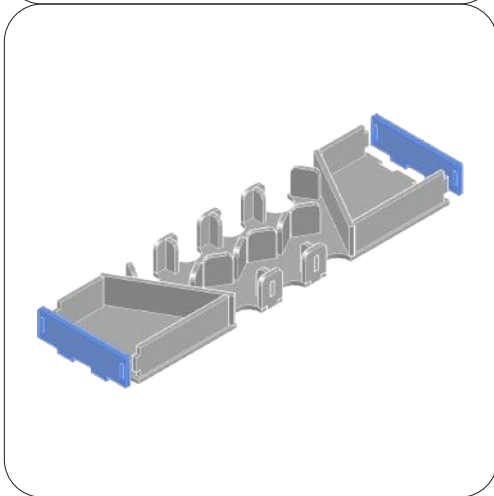
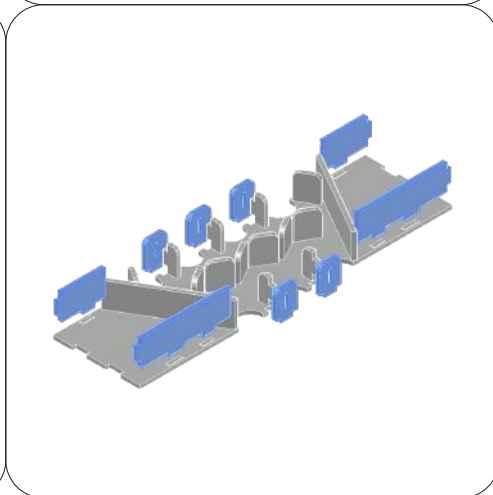
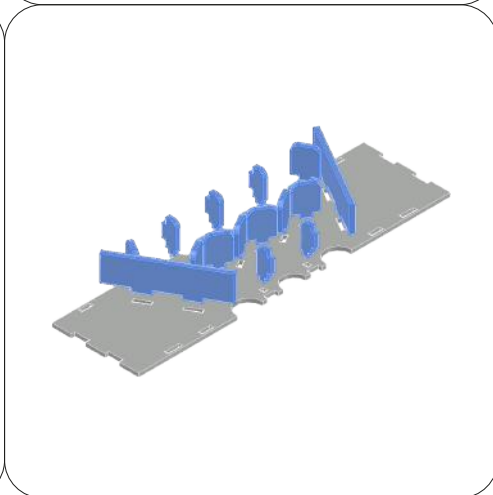
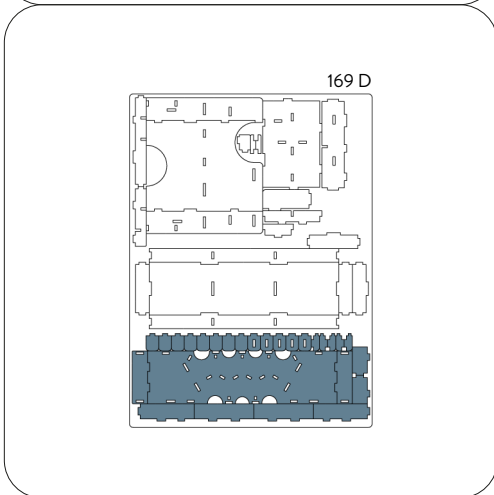
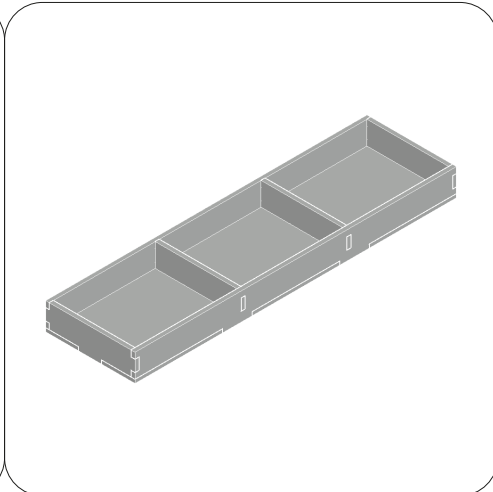
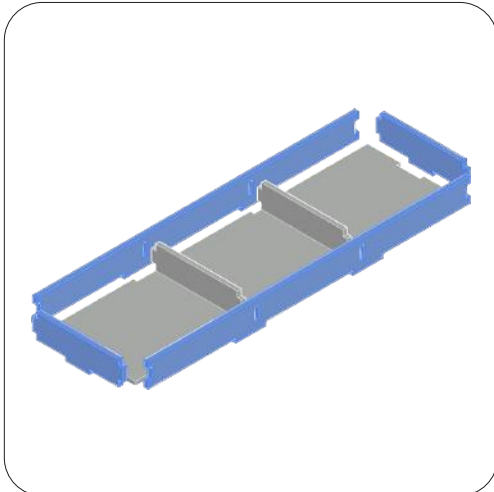

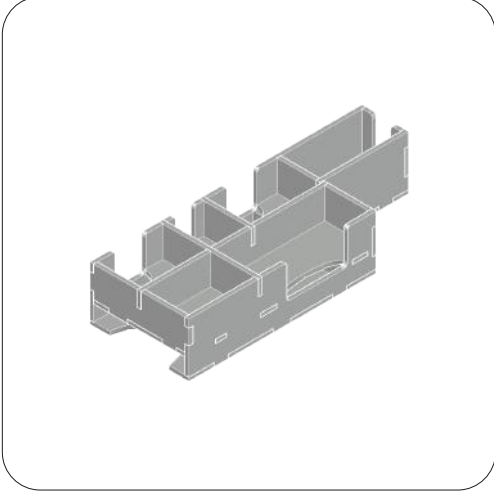
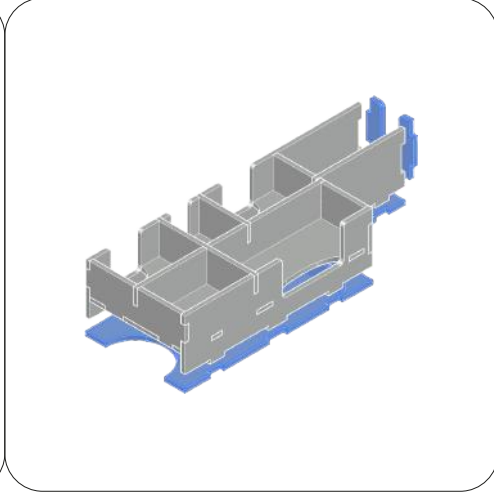
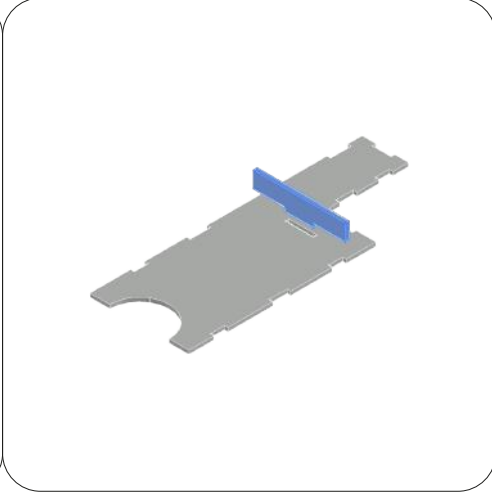
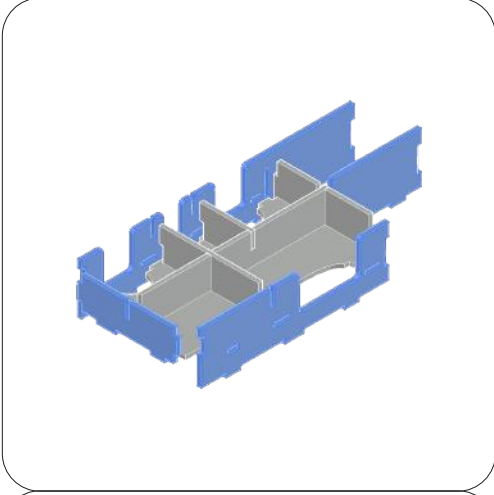
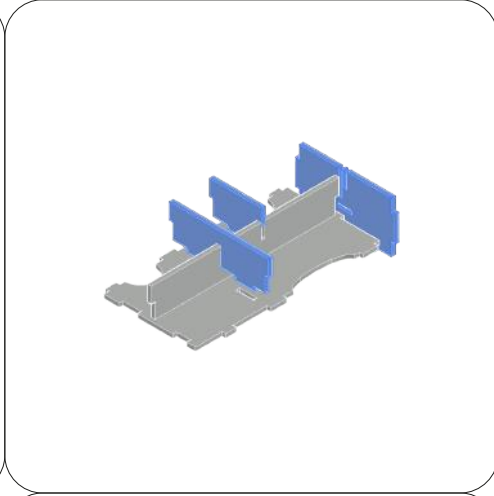
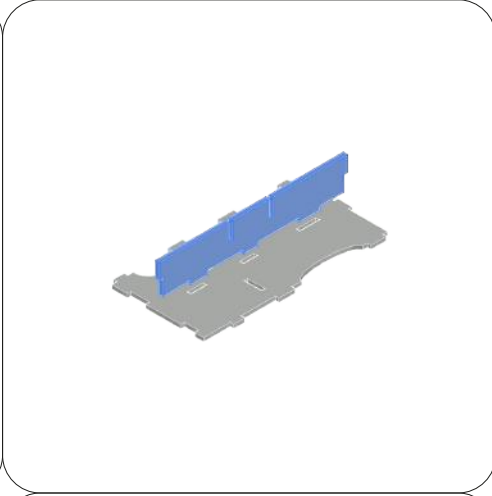
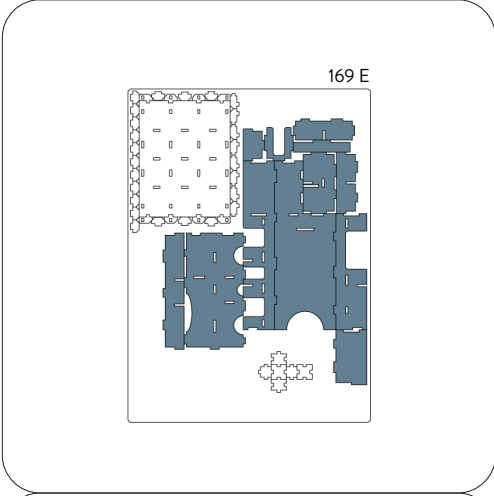
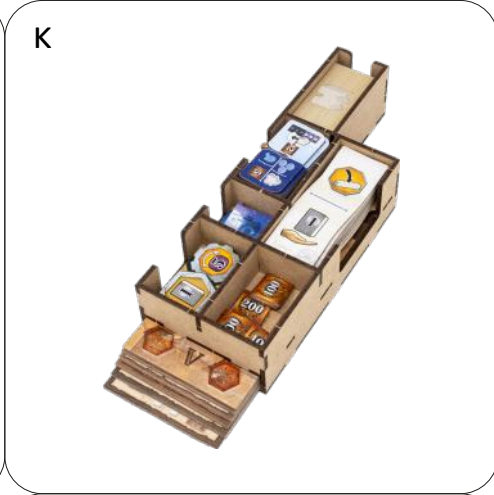
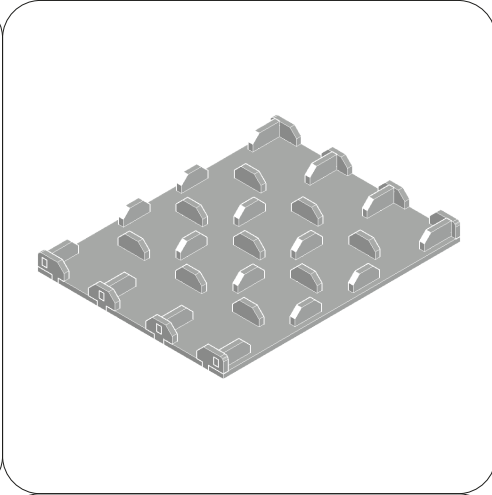
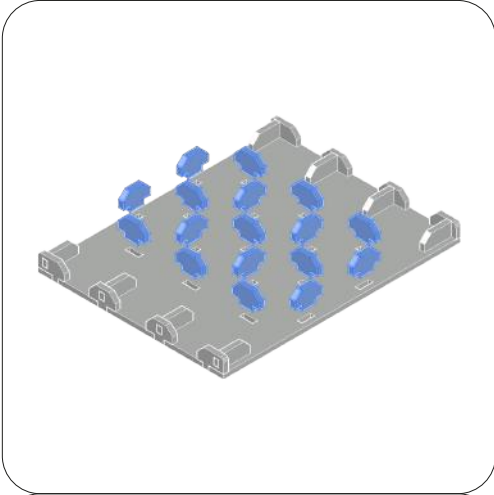

REBOXING SEQUENCE!

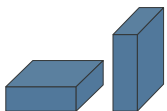

COMPATIBLE WITH BOTH HORIZONTAL OR VERTICAL STORAGE

Follow the reboxing sequence to properly store your organizer. We recommend using a h-band to avoid accidental box opening. Segui la sequenza di reinserimento per riporre nella maniera corretta il tuo organizer. Consigliamo l'utilizzo di una h-band per evitare aperture accidentali.



Non-recyclable waste.
Smaltire i materiali di scarto nell'indifferenziata.

All trademarks and copyrights are the property of their respective owners.
This product is not a toy. Contains small parts that can be swallowed or inhaled. 14+